

Designer's
NOTEBOOK
WINDOW PANELS

Window Panels Offer Many Options — Article VI

PCI's Architectural Precast Concrete Services Committee explains the finer points of designing architectural panels with window openings

Window openings can be provided in architectural precast concrete panels with ease, in any shape or size desired. However, achieving design efficiency requires thoughtful panel system configuration. The most economical wall unit consists of a panel where the window openings are fully contained within one precast piece. The plasticity of concrete lends itself to the manipulation of voids and solids. The design options for window wall panels are extensive:

- They may contain a single opening or a series of windows (Fig. 1)
- They are either one story in height and made as wide as possible, or cast narrower to span vertically for two or three floors (Fig. 2)
- They can be recessed to optimize seasonal solar heat or to reduce glare (Figs. 3, 4 & 5)
- They can be in the same plane (punched), without sills or projections (Fig. 6)
- They can be boxed out from the general wall face (Fig. 7)
- They can be set in a deep coffer with margins projecting slightly (Fig. 8)
- They can be set in a deep recess with or without a projecting sill (Fig. 9)

Window Head Design

Window heads should be designed so they don't splay down and back toward the glass, unless drip details are incorporated into the frame. A drip groove also should be provided under any outward-sloping sills to prevent water from staining the panels. The drip section should be designed in relation to the slope of the concrete surface, as shown in Fig. 10, to prevent water from bridging the drip. To avoid a weakened section, the drip should not be located closer than 1½ inches to the edge of the precast unit. Where the window is not at least three to four inches back, it is difficult to get a drip groove in the panel. Alternate solutions include using a clear sealant bead, plastic drips, or extrusions with a gutter or one inch drip lip.

Precast concrete offers the architect total flexibility in design. This means the designer can produce window panels that:

- Promote the use of a master mold (Fig. 11)
- Offer flat or heavily sculptured profiles (Fig. 12)
- Provide curved surfaces (Fig. 13)
- Work as corner units (Fig. 14)
- Incorporate a bullnose, a cornice or reveals (Fig. 3A)

Mold Considerations

In all cases, a reasonable slope must be maintained on the return edges of openings to ensure sufficient draft to strip the unit out of the mold (Fig. 15). Mold costs are directly related to the complexity of the window panel. Punched flat panels add moderate costs, whereas heavily sculptured panels, such as those shown in Fig. 16, can require expensive molds. As always with precast concrete, repetition of components reduces unit costs.

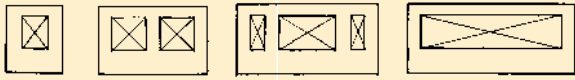

Fig. 1 Narrow, Single, Series, & Wide

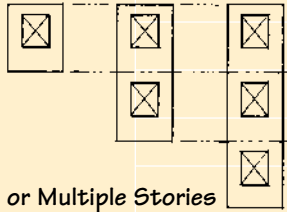

Fig. 2 Single or Multiple Stories

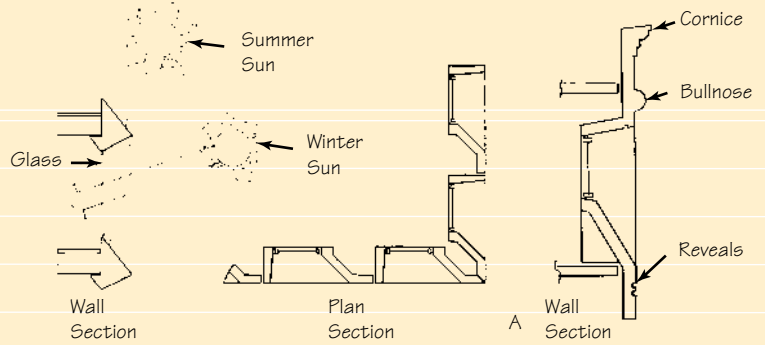

Fig. 3 Window Configurations

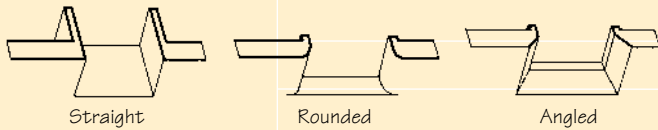

Fig. 4 Jamb or Sill (Rotate 90°)

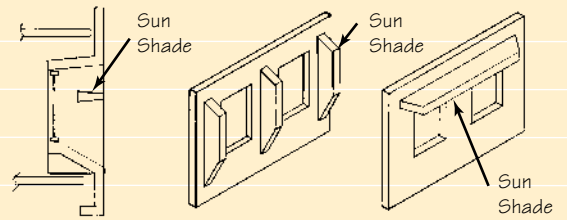

Fig. 5 Shading

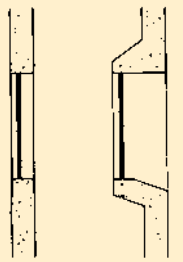

Fig. 6 Fig. 7

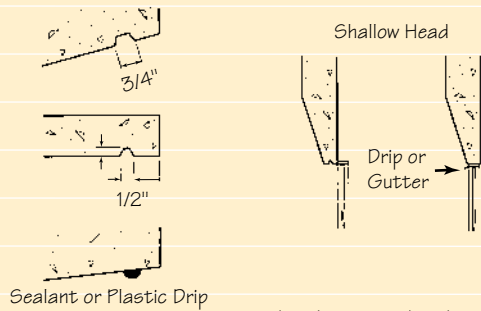

Fig. 10 Drip Details

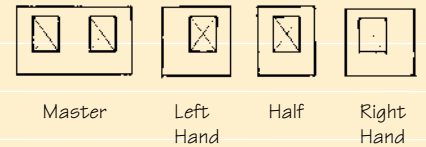

Fig. 11 Master Mold

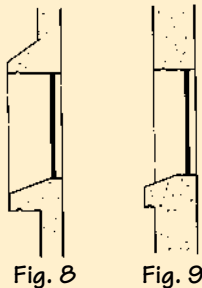

Fig. 8 Fig. 9

Window Detailing

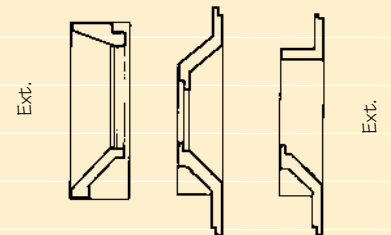
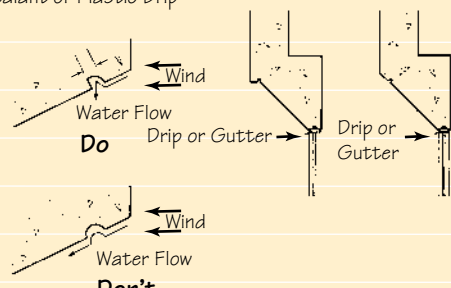

Fig. 12 Sculptured Profiles

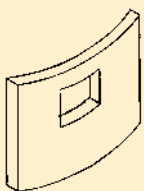

Fig. 13 Curved

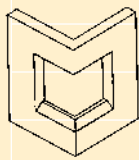

Fig. 14 Corner

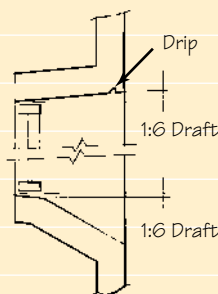

Fig. 15 Draft

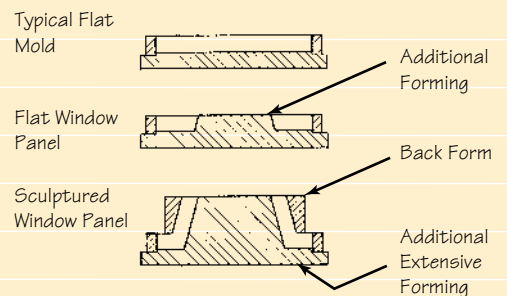

Fig. 16 Molds

Window Wall Panels Offer Diversity, Creativity

Architects John Hesseler, AIA, and Jeff LaRue, AIA, describe the many uses of precast concrete window walls in the architecture of HKS

The Many Uses of Precast Window Wall Panels

HKS Inc., the largest Texas-based architectural firm, has used precast concrete on many projects, a number of which incorporate precast concrete window walls. Because precast concrete offers such an inherently flexible design medium, it provides designers with many options for creative solutions. Color, shape and texture can be manipulated in a variety of ways to achieve the desired aesthetic effect.

Precast window wall panels provide the designer with an unlimited architectural vocabulary of expression. Whether the project's aesthetic intent is traditional or contemporary, precast concrete can be sculpted to fit the aesthetic need. In conjunction with precast concrete wall panels, masonry or natural stone, precast concrete window wall panels provide a significant design feature for any building type. Since this medium can be manipulated into almost any form, its flexibility is limited only by the designer's imagination.

HKS' designers have used precast concrete wall panels on many different building types in a variety of ways to achieve the desired aesthetic intent. Whether the windows are recessed or projected, require some type of shading devices or need classical detailing, precast concrete window wall panels can achieve the goal at a reasonable cost. In addition, clients appreciate the flexibility of design expressions, the durability and weathertightness offered by precast concrete.

The USAA Mid Atlantic Regional Home Office Building in Norfolk, Va. shows many precast design motifs that help provide a quality environment for inhabitants. Projected window sills add visual interest to punched window openings on several façades, while precast concrete sunscreens provide visual interest and solar shading for the long sides of the building.



Addressing Vulnerabilities

Since precast can be formed into almost any shape, many of the vulnerable areas around windows can be addressed in the design of the window wall panels. For example, if the design requires a recessed window, precast concrete can form the entire window surround, including the soffit, sill and jambs. This one-piece design eliminates potential water infiltration and allows quick installation.

Lincoln Towers in Arlington, Va., was designed with precast window wall panels at the base of the building, incorporating arches, reveals and projections to articulate the elements. Precast concrete also is featured significantly at other openings in the façades, such as the balconies and windows at the top of the building. The precast used with masonry in this project adds interest and color to the project.



In addition, precast concrete offers quality and cost-effective construction that many architectural products cannot match. The repetitive nature of many of the fenestration patterns designed for building types such as hospitals, high-rise housing, office buildings and corporate headquarters buildings plays to precast concrete's strength in duplicating one pattern many times. As a result, precast window walls create designs that help make these structures cost-effective and aesthetically successful.

Surface Articulation

Precast concrete window wall panels play a significant role in the development of architectural expression. Windows can be recessed to provide texture and shadowline to a façade, creating architectural interest. Many opportunities for textures also exist when the panels are enhanced with architectural devices such as bullnoses, reveals and chamfers.



The Texas Medical Association building in downtown Austin, Texas, offers vertical ribs of precast around the windows to accentuate the building's verticality and provide surface texture. Recessed windows in the wall panels used on the top floor provide additional visual interest to the façades.



The corporate headquarters for Fina Oil Co. in suburban Dallas features accent bands of precast concrete at the stair towers for the 250,000-sq.-ft. facility. In addition, many stepped profiles were added at the base of the building to accentuate the windows.

The ability of window wall panels to provide visual interest also can improve the building's overall financial performance. In speculative office buildings, when used in full height applications, projected windows can add to the rentable area of the building without major structural provisions.

Color and Texture

Precast concrete can be colored, sandblasted or treated with retarders to provide added surface texture. The aggregates used in the precast concrete can be exposed, providing further variety and interest. Multiple colors can be provided in one panel by combining retarders and sandblasting to expose the aggregate in varying degrees. Formliners also can be used in the molds for the window wall panels to provide texture and variety.



Headquarters for the Joint Commission for Accreditation of Hospital Organizations in suburban Chicago is highlighted by a stepped profile at the window recesses, as well as a heavily exposed aggregate for color and texture.



The Children's Medical Center in Dallas used precast concrete extensively in the exterior envelope. Large recessed window openings add sculptural interest to the overall mass of the project, providing significant solar shading for those specific windows.

Shading Devices

Architects must be able to design buildings that are cost-effective to operate as well as "good looking." Operational efficiency is a known marketable asset for a project, whether the building is being designed as speculative or build-to-suit. Shading devices integrated with window wall panels provide visual interest and reduce solar gain.



The USAA Retirement Center in San Antonio features precast concrete throughout the façade. Window panels on the low-rise structures highlight a variety of profiles and treatments, as do the balconies and window areas of the tower of the project.

Attachment and Erection

Whether window wall panels span column-to-column or floor-to-floor, the repetition of design affords the same repetition for attachment and erection. This contributes to the panels' economy and speed of erection.

Fenestration Fabrication and Securement

Attachment to the structure is simple, normally requiring only four points per panel. The attachments of panels that span column to column usually are covered by interior drywall. Gravity connections for window wall panels spanning floor-to-floor normally are pocketed at the floor slab, eliminating conflicts with interior finishes. Panel tiebacks, located above the ceilings, are typically small and simple.

Window wall panels offer two significant advantages for fabricating and securing fenestration. First, repetition of panel design can contribute to an accelerated schedule by



Two colors of precast concrete were used on the M.D. Anderson Cancer Center in Houston, Texas. Recessed window openings on the bed tower provide shadowlines and detail to the overall façades.

providing control of fenestration rough openings.

The process allows for faster fabrication of window frames and glass.

The second advantage relates to securing window units directly to the panels so the panels resist all wind loads. The attachment requires an isolator in northern climates to minimize thermal transference. Supporting members for interior-finish materials associated with window wall panels must support only finish materials, allowing them to be much lighter and economical. Other exterior materials don't have the capability to support window attachments. In many cases, extensive back-up systems are needed to resist wind loads and secure window frames.

Condensation Control

Just as with the form-design flexibility, window wall panels can be configured to help manage condensation that forms on the backside or interior face. By using slopes and washes, panels can be shaped to direct water to weep tubes at panel-to-panel joints or into fenestration-head framing designed to collect, manage and redirect water back to the exterior. This requires that thermal insulation be held away from the inside surface so moisture can proceed down to collection systems without contaminating the insulation. Impaling pins allow this to be accomplished easily, and they are available with shoulders holding back-up discs and insulation away from panel.

The examples illustrate how we at HKS take advantage of the benefits offered by precast concrete window wall panels in some recent projects. They also show the variety of options available for creating distinctive and cost-effective structures with these components.

—John Hesseler, AIA and Jeff LaRue, AIA, HKS Inc., Dallas, Texas