

Designer's
NOTEBOOK
CORNICES

Designers can create more exterior interest and energy savings by taking advantage of the variety of possibilities with these projecting overhangs

PCI's Architectural Precast Concrete Services Committee outlines the potential of cornices in the second of a series focusing on panel details.

Precast Cornices Expand Options - Article III

Cornices provide a number of significant aesthetic and functional advantages when designing virtually any type of building. Their ability to break up long expanses of the façade adds visual interest, and they can shade windows from sun, reducing energy costs and other internal shading needs. Designers who keep the available options in mind as they plan their projects will find a host of possibilities that will serve them well.

A cornice consists of a horizontal projecting overhang comprising multiple surfaces, planes and profiles with infinite variations. It usually is located along a parapet or at the top of a given plane. The cornice crowns or finishes the part to which it is affixed.

Cornices can be used in a variety of styles and combined with several different components to achieve different purposes. Options include cornices that are:

- Made to look contemporary (as in Figs. 3-2A, 3-2B and 3-2C).
- Made to look traditional (as in Figs. 3-3A, 3-3B and 3-3C).
- Doubled to create even more design interest (as in Fig. 3-4).
- Incorporated with a reveal (as in Fig. 3-5).
- Incorporated with a void to reduce weight and add coping on the crown (as in Fig. 3-6).
- Created so large that it requires special support. For instance, a steel structure may require bracing to prevent rotation of structural members (as in Figs. 3-7A, 3-7B and 3-7C).
- Incorporated with dentils (as in Fig. 3-8).

Eyebrows also offer a design element that can add interest similarly to a cornice. An eyebrow is a horizontal projecting overhang comprised of a single profile that projects further than a cornice. It usually is located above a window or at a parapet (as shown in Fig. 3-9).

Mold costs for either component will depend on the degree of complexity and the size of the projection (Fig. 3-1). Both cornices and eyebrows may be continuous, interrupted, arched or peaked.

Dissimilar finishes may be used on adjacent surfaces (Fig. 3-2B). The plasticity of concrete along with repetitive precasting makes it economically feasible to use complex profiles and configurations. (For more on the value of repetition and options available with molds, see the previous article in the Designer's Notebook series in the Winter 1998 ASCENT.)

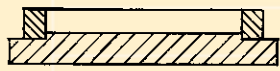

Typical Flat Mold

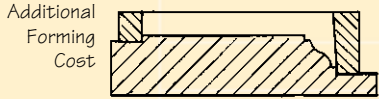

Typical Cornice

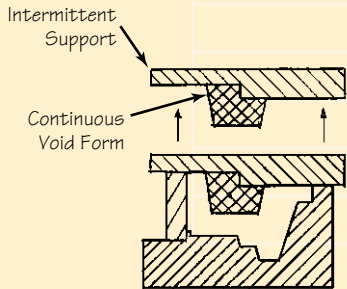

Ornate Cornice

Molds Fig. 3-1

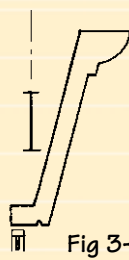

Fig. 3-2A

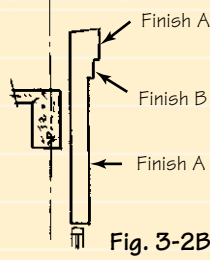

Fig. 3-2B

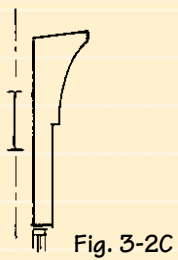

Fig. 3-2C

Contemporary

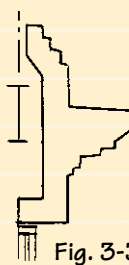

Fig. 3-3A

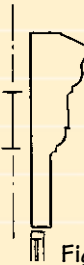

Fig. 3-3B

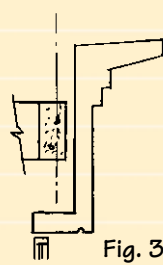

Fig. 3-3C

Traditional

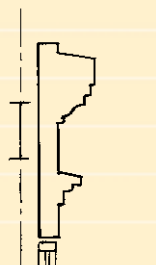

Fig. 3-4
Doubled

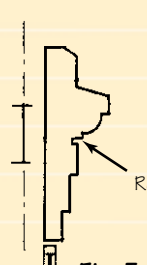

Fig. 3-5
with Reveal

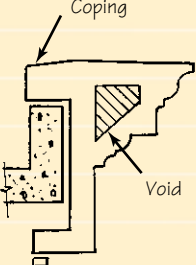

Fig. 3-6
with Coping and Void

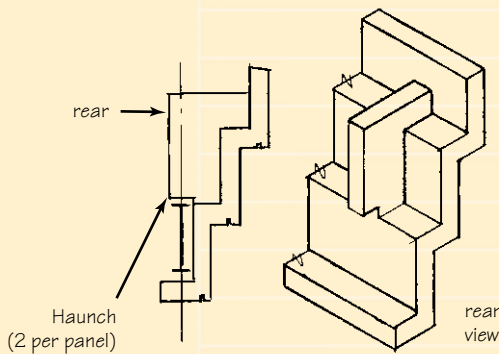

Fig. 3-7A
Special Haunch on Panel

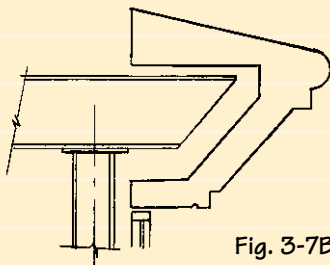

Fig. 3-7B

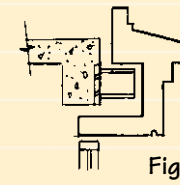

Fig. 3-7C
Special Structural Supports

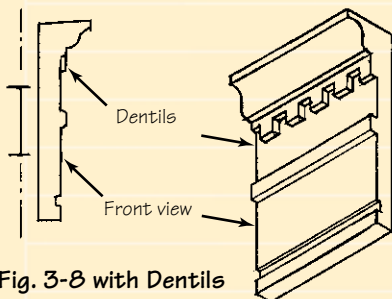

Fig. 3-8 with Dentils

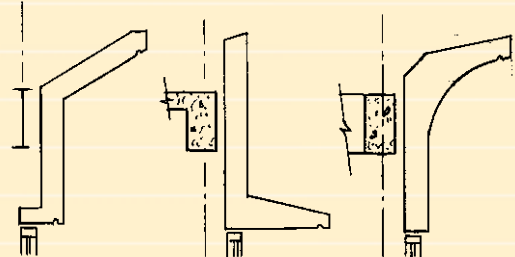

Fig. 3-9 Eyebrows

Precast Cornices Can Offer Decorative, Functional Touch

Architect Richard E. Fencil describes the advantages provided by precast cornices, offers suggestions on specifying them, and shows how his firm uses them on projects

The cornice or “corona” finds its origin in the classical architecture of Greece and Rome. Its place in the ancient scheme of things was to function as the crown or “head” of the building, “controlling all beneath it.” As an architect whose home town and professional practice is in Chicago, I find the cornice an active part of the architectural excitement of many of our urban buildings.

Strolling through the Chicago Loop, you’ll notice the wonderful cornices that top structures like The Reliance Building, The Goldblatt Building and The Rookery, adding grandeur and style. Or you can observe the intricately formed cornice at the Shubert Theatre Building; the gabled cornice at the Monroe Building; or the ballustrated crown of the Chicago Cultural Center.

Three Primary Functions

My architectural-historian friends suggest to me that the cornice, as an element of the façade, has three primary functions:

- It provides “the termination” of the vertical spread of the building. It’s the top; pure and simple.
- It provides a balance and proportion to the entire façade, acting as a counterweight to the aesthetically heavier base of the building.
- When cantilevered away from the plane of the main façade, the cornice serves a function, acting as a rain shield for the upper floors and helping to minimize dirt streaking and water stains.

Historians also might suggest that when used as a horizontal element that’s not situated at the building’s top, the traditional cornice-shaped element becomes an “eyebrow” or “shelf” offering additional aesthetic proportion and definition to the entire facade. If one believes that buildings encompass the three basic parts of base, middle and top, these eyebrows can define the transition from one part to another or provide the transition from one type of building element to another, such as with articulated column capitals.

Today’s architectural vocabulary also might employ this device as a light shelf (reflecting light) or shadow maker. Either will develop interesting and ever-changing light and dark patterns on the surfaces below.

Design Options Proliferate

Whether used as the top piece or as an eyebrow, the architectural precast concrete cornice shape offers architects a multitude of design possibilities. For instance, a cornice easily can cantilever past the structural roof slab or project away from the façade’s plane without needing complex additional support. Conventional masonry would require extensive reinforcing or be limited to the corbeling proportions of the masonry unit, while cantilevered curtain wall systems (which need internal stiffening) are controlled by the deflection limitations of the glass.

When the design emphasis articulates a “heavy, large expression at the top of the building,” precast concrete pieces can accomplish both the aesthetic and the functional needs of this concept. Since these precast concrete cornice and eyebrow elements are plant-fabricated, the quality control of the shapes and finishes surpasses ones that must be field-fabricated.

Because of the panel’s spanning capabilities, the weight of the cornice or eyebrow panel can be transferred easily to the building’s structural columns. This isn’t possible with masonry. Since traditional masonry has limited span capability, the load of the masonry cornice or eyebrow is often transferred to slab edges that might require additional support or stiffer beams.

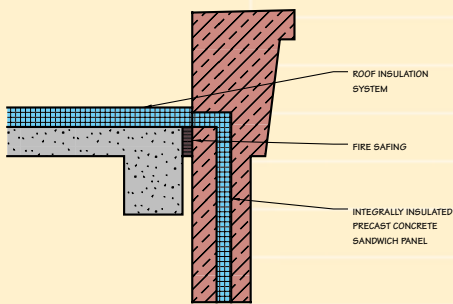

SANDWICH PANEL

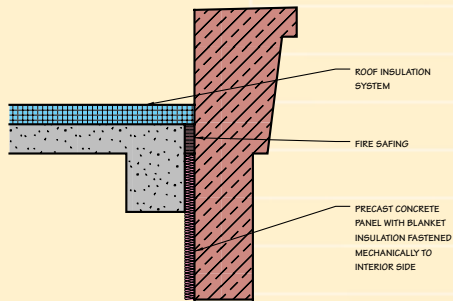

SINGLE WYTHE PANEL

Fig. 1: Wall insulation can mate easily with roof components, providing a tight seal, whether an insulated sandwich wall panel (top) or a single concrete wythe (bottom) is used.

Plasticity Aids Shaping

Shape selection of precast concrete cornices is virtually unlimited, due to the wet concrete’s inherent plasticity. Shape truly is limited only by forming capabilities. Likewise, facing and finish selection are excellent. Options for facing materials comprise natural-stone veneer, clay masonry elements cast in the panel, ceramic or porcelain tile veneers, terra cotta, or a combination of finishes.

When using the concrete face mix as the final finish, the PCI “Color & Texture Selection Guide” is an excellent resource. At Loeb Schlossman & Hackl/Hague Richards (LSH/HR), we also find that dialogue with our local precasters early in the project helps us understand both forming and finishing possibilities, minimizing problems.

Good design development of any wall system takes a good understanding of all components within that wall assembly. In cold weather climates like Chicago, it is desirable to locate the wall insulation so it mates easily with the roof insulation. This approach can be achieved with precast concrete cornice or parapet panels, either single-wythe or in sandwich panels (see Fig. 1). Developing this with masonry cavity wall-type parapets is difficult.

Flashing Options

As an architectural firm equally interested in a project’s technical detailing and its aesthetic design, LSH/HR has developed several cautions when designing cornices and parapets fabricated from architectural precast concrete. We believe the interface between wall and roof components provides one of the most technically challenging details on any project. Precast concrete cornices or parapets need to be carefully detailed at this interface due to the uniqueness of their materials and connections.

Since it’s desirable to offer a continuously uniform base flashing detail, precast cornice connections to the building structure should not be allowed to disrupt this continuous detail. Do not allow the precast design engineer to modify the cornice’s back with haunches or connections that require a major change to the roof flashing. Our office tries to bury the

connection in the insulation or connect to roof structural components below the flashing line.

LSH/HR also tries to avoid terminating roof flashing within cast-in or sawn-in reglets in the back face of precast cornice or parapet panels, since reglets do not act as through-wall flashing. The capillary nature of many cornice materials can actually pull water around the reglet, allowing it to work its way beneath the flashing termination. In addition, the reglet becomes discontinuous at the panel-to-panel caulk joint of a precast cornice system. If this caulk joint fails, water intrusion behind the flashing is inevitable.

With a straight-backed cornice panel, our philosophy is to extend the roofing system up the back of the piece and over the top, covering the entire back of the panel including the panel-

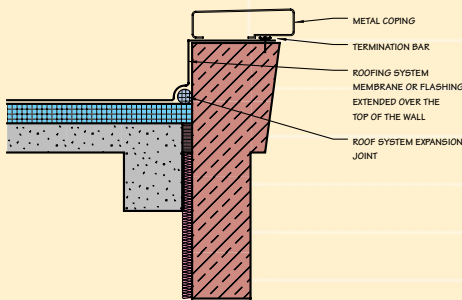

Fig. 2: With a straight-backed cornice panel, Fencil completes the roof detail with a metal, stone or precast coping piece to hide the termination.

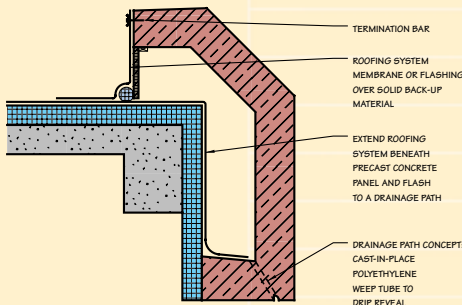

Fig. 3: To prevent leakage, Fencil adds an extra piece of conventional base flashing over the back of panels along the roofline, flashed out at the extended roof membrane beneath the C-shape.

to-panel caulk joint. The roof termination is completed at the top with a metal, stone or precast coping piece to hide the termination (see Fig. 2). With a C-shaped piece, we prefer to extend the main roofing under the precast and into a drainage cavity behind the precast cornice below the roof line.

In addition, we will add an extra piece of conventional base flashing over the panel's back and then terminate the additional piece on the cornice's back near the top. In this way, if the horizontal surfaces along the cornice's top were to leak, or the precast-to-precast caulk joint fails, or the roof termination leaks, the infiltrated water won't enter the building. Instead, it will be flashed out at the extended roof membrane beneath the C-shape (see Fig. 3).

This philosophy also extends to eyebrows or other precast "shelf" elements whenever practical. Architects should be careful to consider the type and location of the precast concrete connections with this approach, as frequently these connections can puncture the flashing.

LSH/HR has found that working with the precast engineer during the shop-drawing connection phase helps avoid or minimize this problem.

Precast cornice pieces are generally supported at or near the

columns of the building. This provides an excellent and efficient way to transfer the panel's dead load. However, this load transfer presents another roofing-to-panel concern: differential live-load deflection between the roof edge and the precast cornice panel. The cornice isn't subject to the roof's live-load deflection since the cornice is supported by the column, not by the roof edge.

This translates into a possible downward deflection differential of one inch for a 30-foot spanning piece of precast cornice or parapet and a roof edge spandrel beam designed for $L/360$. The architectural designer must be aware of this differential movement and accommodate the roof system with a perimeter expansion joint at the cornice-to-roof system (as shown in Figs. 2 and 3).

Design Examples

Selected Loeb! Schlossman & Hackl / Hague Richards projects in which architectural precast concrete cornices and eyebrows have played a successful role in the design philosophy include: Holley Court Parking Facility in Oak Park, Ill.; Leaf North America's Corporate Headquarters in Lake Forest, Ill.; and Cook County Hospital Parking Facility in Chicago, Ill.



Holley Court Parking Facility in Oak Park, Ill., features precast concrete details that add both character and interest to the cornice and façade. The goal was to suggest residential rowhouses rather than a parking structure. Photo: © Steinkamp/Ballog Chicago



Leaf North America's Corporate Headquarters in Lake Forest, Ill., features a distinctive limestone-finished stepped cornice. The design element, articulated with triglyphs over each column and dentil moldings between, provided an economical way to give prominence to this suburban office building. Photos: George Lambros Photography



At Loeb! Schlossman & Hackl / Hague Richards, we have found the use of architectural precast concrete within our design palette offers flexibility in shape, form and finish while providing our clients with cost-effective solutions, long-term durability and speed of installation.

This rendering of the Cook County Hospital Parking Facility in Chicago used precast concrete cornice, column covers and spandrels with a number of horizontal reveals and a variety of textures to upgrade its image and create a more intimate scale.



— Richard E. Fencil, AIA; Director of Technical Services, Loeb! Schlossman & Hackl / Hague Richards, Chicago, Ill.